

Section: D-D
 S 1:10

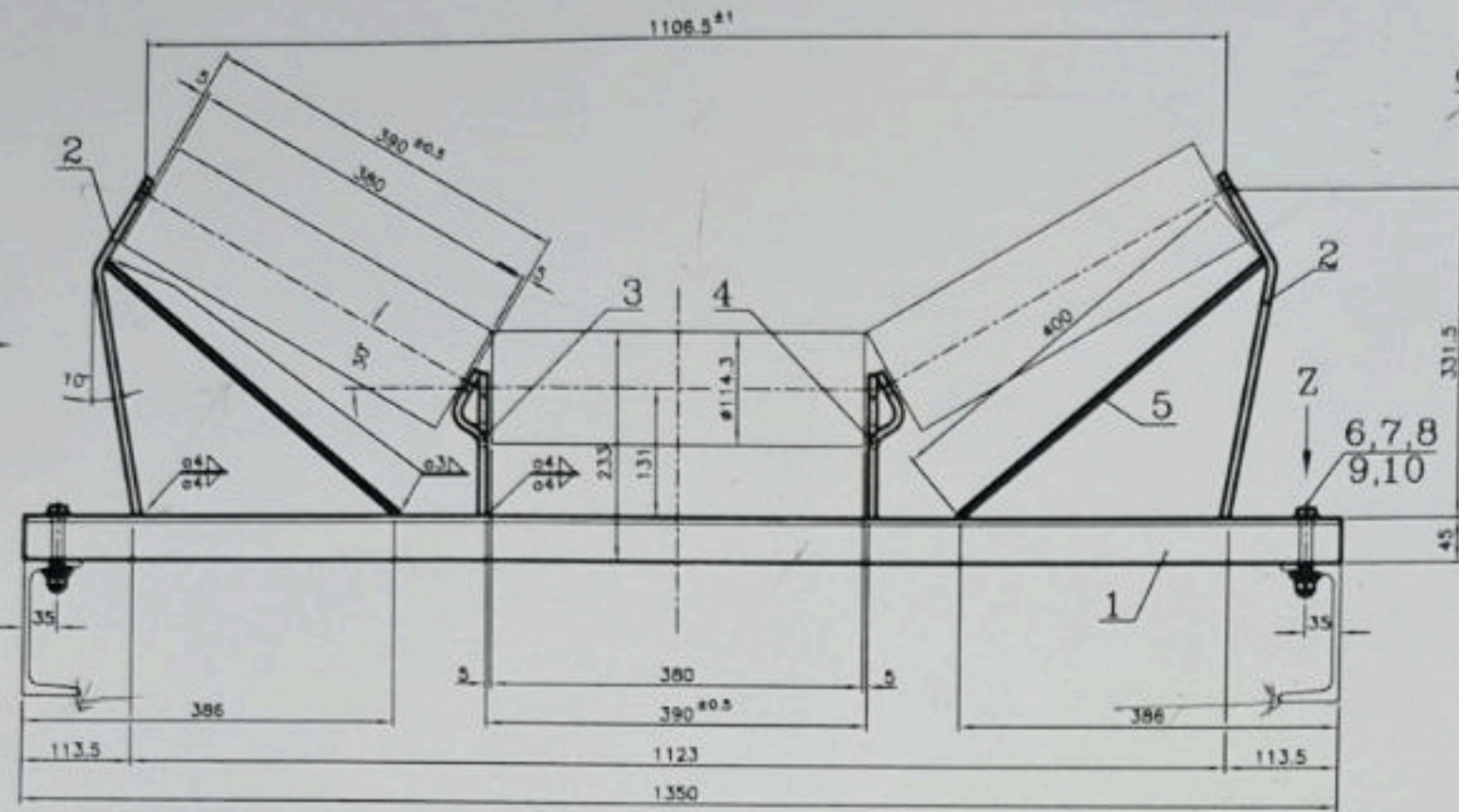

Conveying direction

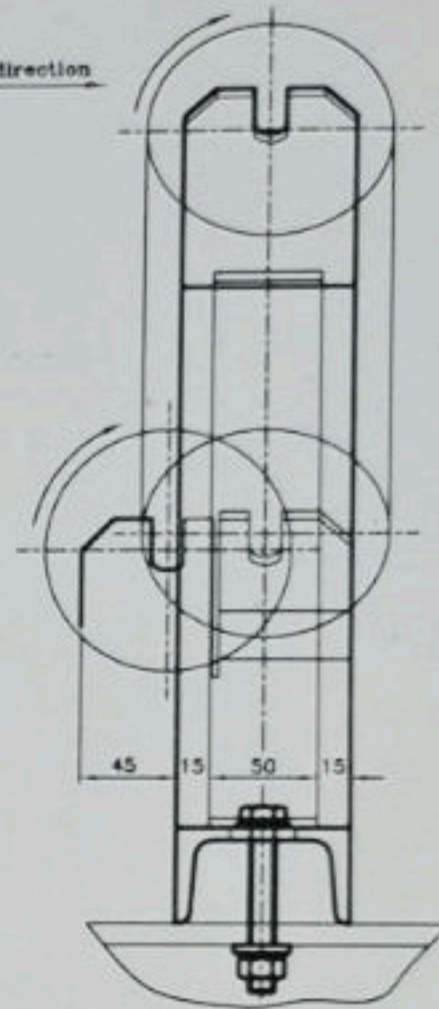

View: V
1:2.5

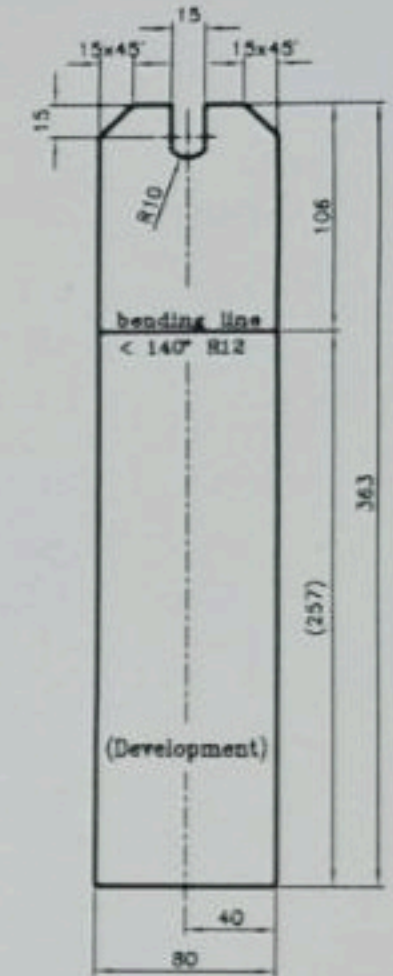
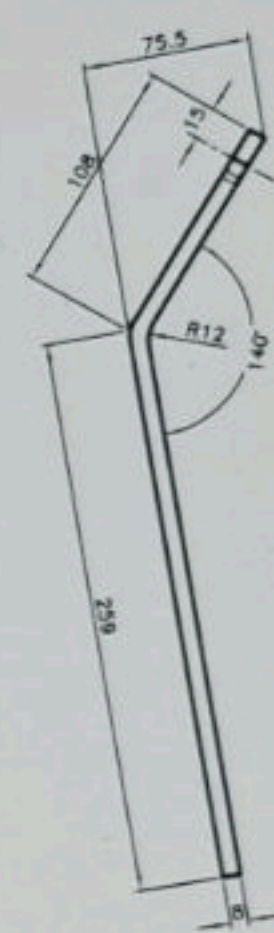

No. 2
1:2.5

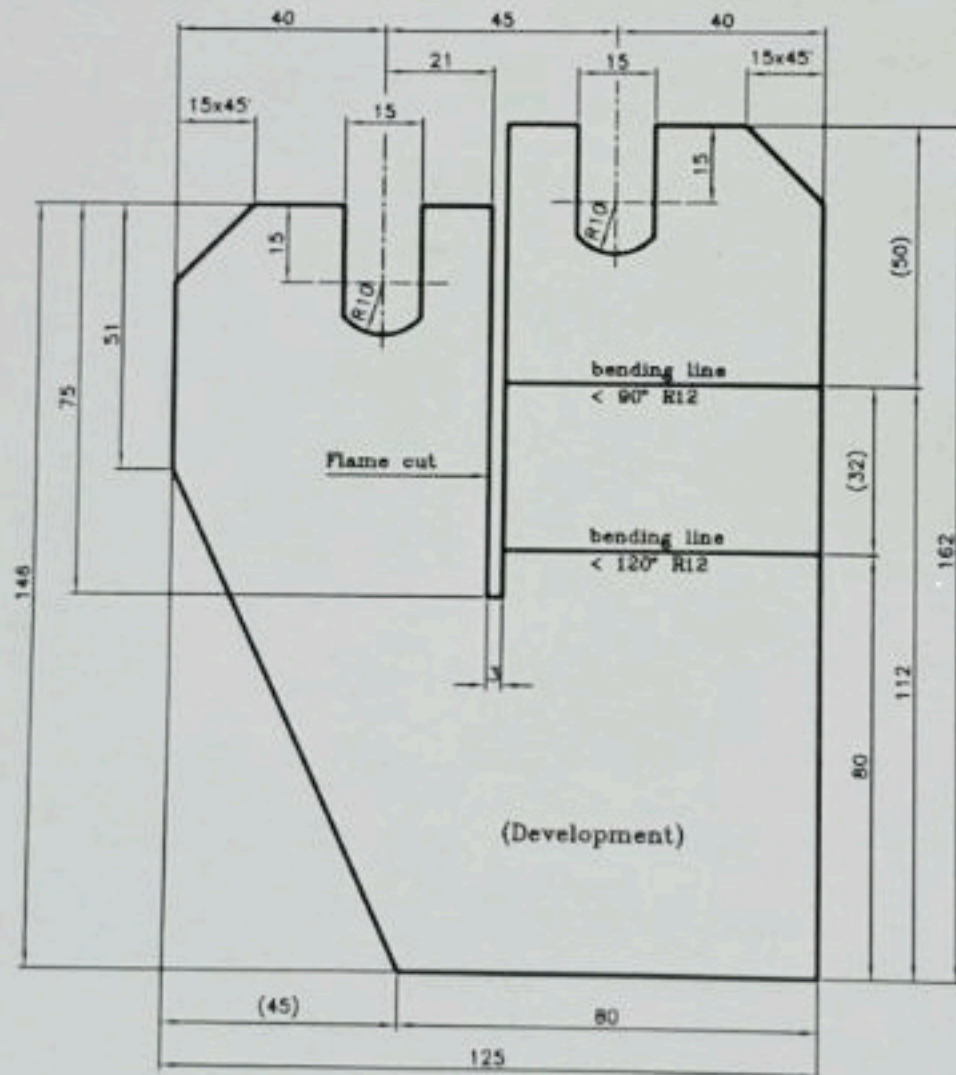
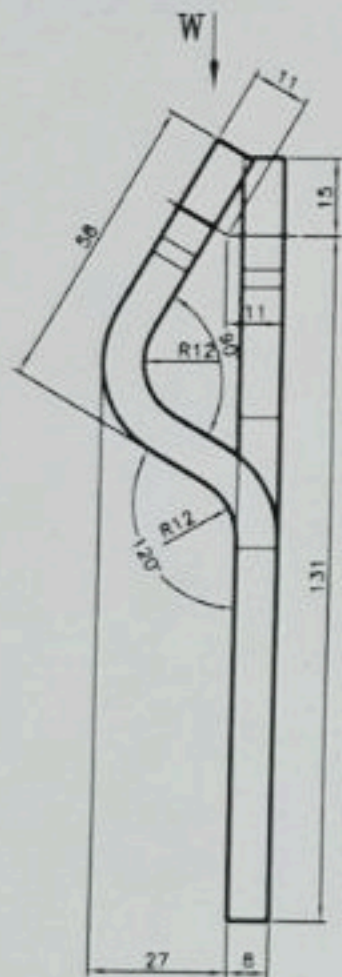

No. 3
Item 4 is image of item 3 on mirror. 1:1

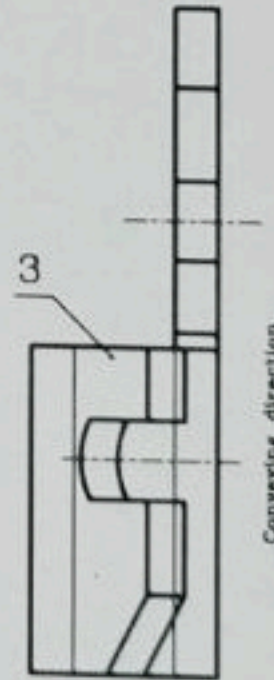

View: W

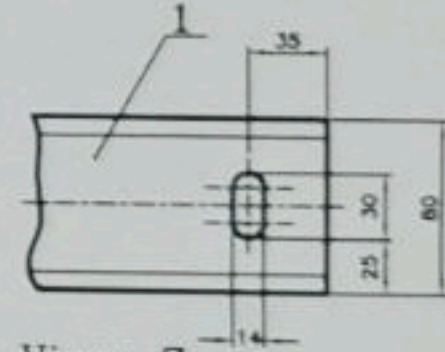

View: Z
1:2.5

- Free tolerance DN 148 a

Rev.	Date	Name	Description	1/8	1/16	1/32	1/64	1/128	1/256
1	14/08/2005	H. Mousavi	Design						
2	14/08/2005	H. Mousavi	Draw						
3	14/08/2005	H. Mousavi	Check						
4	14/08/2005	H. Mousavi	Approved						

MAZANDARAN CEMENT Co.

Title: Idler set 1000-#114.3-30' Extension

Drawing number: 2.544.13.344.100.08.00

Scale: 1:2.5

1, 2, 3

